



Emilia Wall Brackets

light

art. 07-684

ZANCA 15 LEGGERA

Ideal for fixing masts used in the antennas and dishes installation.

Equipped with welded plate on the base with two holes for wall mounting using anchor bolts or threaded rods.

The tubes are made of steel, hot dip galvanized to ensure high quality and durability. The protection of the zinc cladding is of 50/85 microns thick.

The measures are in mm, unless otherwise specified.

Dimensional and thickness tolerances are allowed by the regulations that establish the quality of the raw materials used.



Code	07-684	
Item	ZANCA 15 LEGGERA	
SQUARE POLE		
Height	cm	15 (F)
Side	mm	35 (G)
Thickness	mm	2
PLATE		
Thickness	mm	5
Lenght	mm	170 (A)
Width	mm	50 (B)
FIXING HOLES		
No.		2
Dimensions	mm	20x11
U-BOLTS		
Lenght	mm	125 (E)
Width	mm	40 (C)
Thickness	mm	4
For masts Ø	mm	25 ÷ 60
Screws		QST M8x60 mm
Distance between screws holes	mm	95 (D)

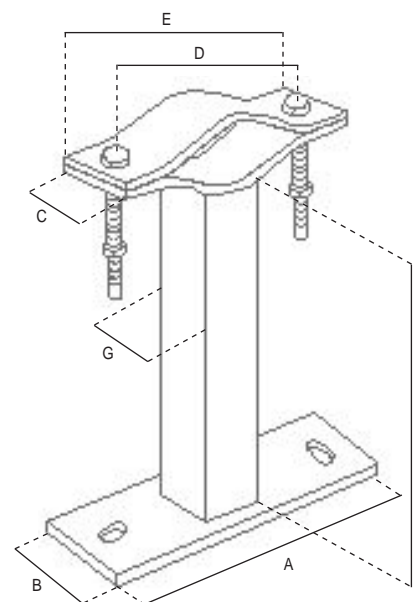

Single packaging

Packaging	Dimensions LxWxH (mm)	Weight (Kg)
Bracket	170x50x185	1,0

