



Expansion brackets of full rod

art. 07-582

ZANCA AD ESPANSIONE 25 cm TONDINO PIENO

Equipped with anchor bolt, indicated for fixing masts used for antennas and satellite dishes installation.

The tubes are made of steel, electrolytically galvanized.

The measures are in mm, unless otherwise specified.

Dimensional and thickness tolerances are allowed by the regulations that establish the quality of the raw materials used.



Code	07-582	
Item	ZANCA AD ESPANSIONE 25 cm TONDINO PIENO	
POLE		
Ø	mm	18
Thickness	mm	1,5
Lenght	mm	250 (A)
Total lenght	mm	300 (A+B)
ANCHOR BOLT		
Type	M10	
Ø	mm	18
Lenght	mm	50 (B)
U-BOLTS		
Lenght	mm	125 (E)
Width	mm	30 (C)
Thickness	mm	4
For masts Ø	mm	30 ÷ 60
Screws	QST M8x60 mm	
Distance between screws holes	mm	95 (D)

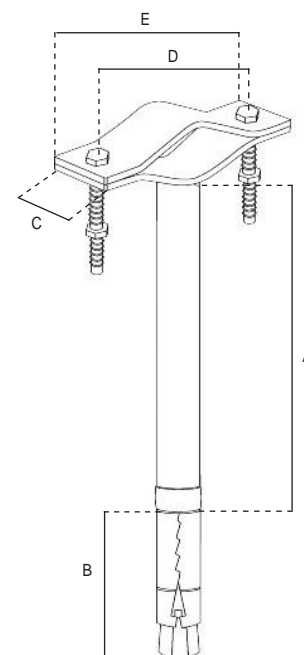

Single packaging

Packaging	Dimensions LxWxH (mm)	Weight (Kg)
Bracket	332x130x30	0,62

