



Brackets to be wall up

Light brackets

art. 07-556 ZANCA LINEARE 35 cm

Wall bracket, indicated for fixing masts used for antennas and satellite dishes installations.

The tubes are made of steel, electrolytically galvanized.

The measures are in mm, unless otherwise specified.

Dimensional and thickness tolerances are allowed by the regulations that establish the quality of the raw materials used.



Code	07-556	
Item	ZANCA LINEARE 35 cm	
STEEL STRIP		
Lenght	cm	33 (A)
Width	mm	30 (B)
Thickness	mm	3
U-BOLTS		
Lenght	mm	85 (C)
Width	mm	30 (D)
Thickness	mm	3
For masts Ø	mm	25 ÷ 45
Screws	QST M6x45 mm	
Distance between screws holes	mm	65 (E)

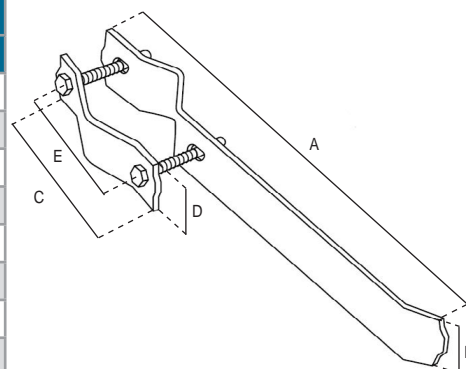

Single packaging

Packaging	Dimensions LxWxH (mm)	Weight (Kg)
Bracket	330x30x50	0,30

