

Parabole in alluminio serie PO 120 G

Aluminium satellite dishes PO 120 G series

CE

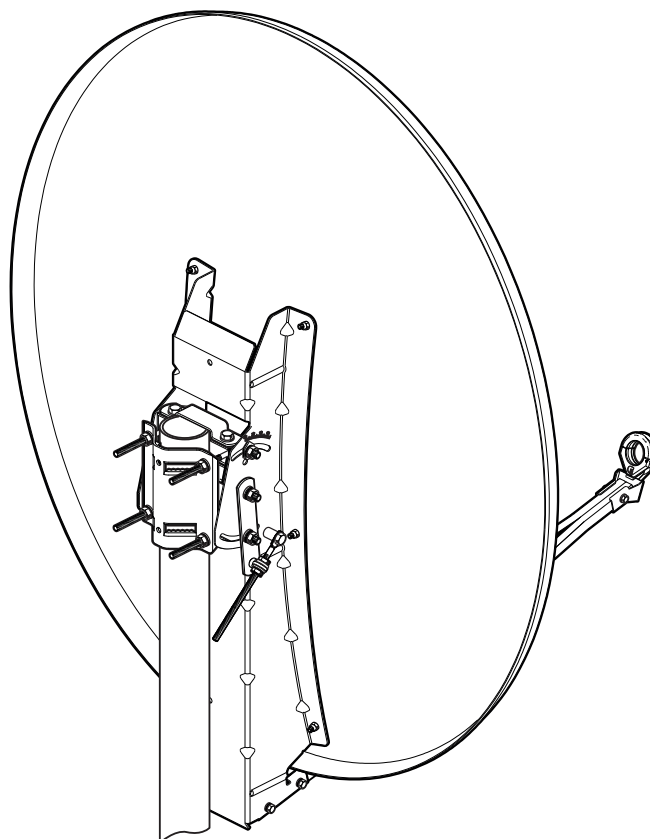

WARNINGS

We strongly encourage you to read this manual before installation and use of the product and strictly observe the recommendation hereof.



Installation shall be carried out by qualified personnel. Mounting instruction has to be carefully observed.



For installation and use, please observe all specific regulation and laws applicable in the destination country.



Carefully read all safety regulations. Failure to observe the indications reported, can cause serious damages to third parties.



If not otherwise indicated, for tightening of screws, bolts and in general threaded rods, refer to applicable figures reported in Tab. 2 in the paragraph General Installation Instructions for GIBERTINI Antennas

NOTES ABOUT DISPOSAL



The barred bin symbol indicates that the product must be disposed of separately from other waste and cannot be thrown into the domestic waste at the end of its life. The user will therefore take the appliance at the end of its life to the suitable separated collection centres for metal parts waste in their own town. An adequate separated collection for sending of the appliance to recycling, treatment and environmentally compatible disposal helps to avoid possible negative effects on the environment and on health thus favouring the reuse and recycle of the materials of which the appliance is made of. The unauthorised disposal of the product by the user causes the application of administrative fees provided for by the regulation in force.



The producer reserve the right to change specifications to products and to documentations without prior notice.

Rev. 0 01.2017



CONTENTS OF THE PACKAGE

CE

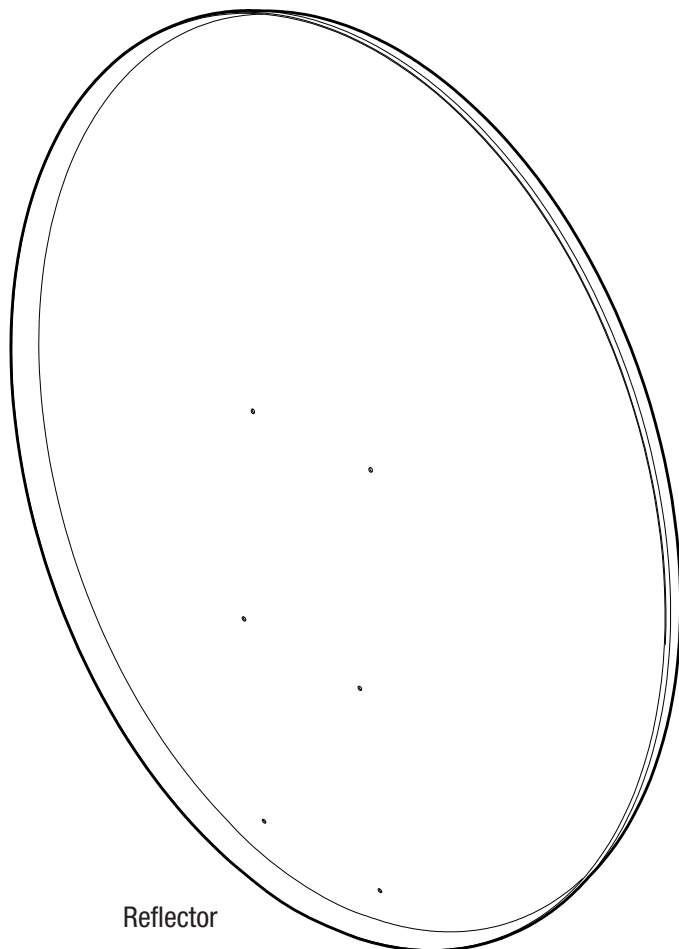

Reflector

n° 1 RL125

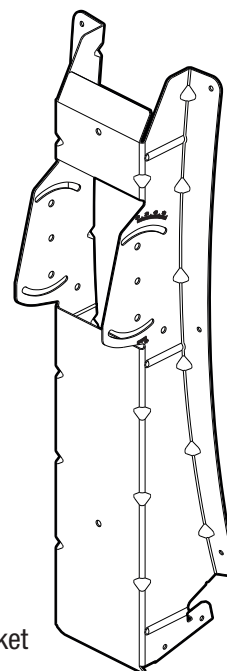

Bracket

n° 1 SIL125



n° 1 SPL125

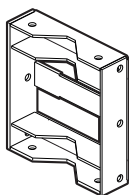

n° 1 SCL125



n° 1 SB125

Pole Clamp components

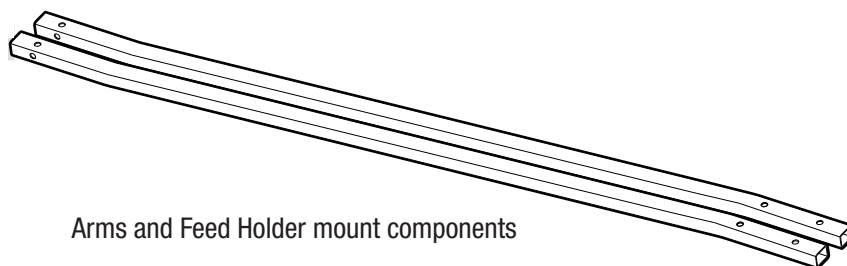

Arms and Feed Holder mount components

n° 2 TRL125F



n° 1 SIN150



n° 1 SSCPAP



CONTENTS OF THE PACKAGE



1 Elements and thread parts for Pole mount unit

 n° 2 M8x20 - ISO 4017 - UNI 5739 - DIN933

 n° 6 M8 - ISO 4033 - UNI 5587

 n° 6 Ø8 - DIN 6798A - UNI8842A

 n° 6 Ø8 - ISO 7089 - UNI 6592 - DIN125A

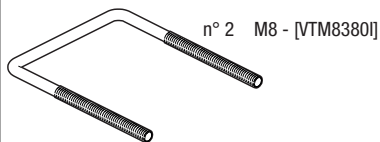

3 Elements and thread parts for Bracket and pole mount unit assembly

 n° 3 M8 - ISO 4033 - UNI 5587

 n° 3 Ø8 - DIN 6798A - UNI8842A

 n° 2 Ø8 - ISO 7089 - UNI 6592 - DIN125A

 n° 1 [VHIPID-G]

 n° 3 M8x170 - ISO 4014 - UNI 5737 - DIN931

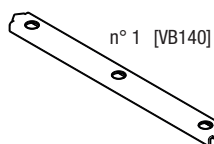

2 Elements and thread parts for Elevation adjuster

 n° 4 M8 - ISO 4033 - UNI 5587

 n° 2 Ø8 - DIN 6798A - UNI8842A

 n° 2 Ø8 - ISO 7089 - UNI 6592 - DIN125A

 n° 1 L=30 - [VP030]

 n° 1 M8x40 - ISO 4017 - UNI 5739

 n° 1 L=20 - [YVD20G]

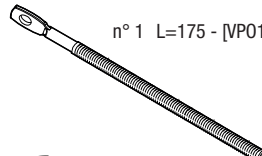
 n° 1 L=175 - [VP0175]

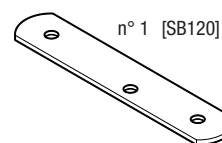

4 Elements and thread parts for Arms and feed holder mount

 n° 5 M6 - ISO 4032 - UNI 5588 - DIN934

 n° 5 Ø6 - DIN 6798A - UNI8842A

 n° 5 Ø6 - ISO 7089 - UNI 6592 - DIN125A

 n° 4 M6x25 - ISO 4017 - UNI 5739 - DIN933

 n° 1 M6x45 - ISO 4017 - UNI 5739 - DIN933

5 Elements and thread parts for Antenna reflector

 n° 6 M6 - ISO 10511 - DIN 985 - UNI7474

 n° 6 [VTC612]



ASSEMBLING STEPS

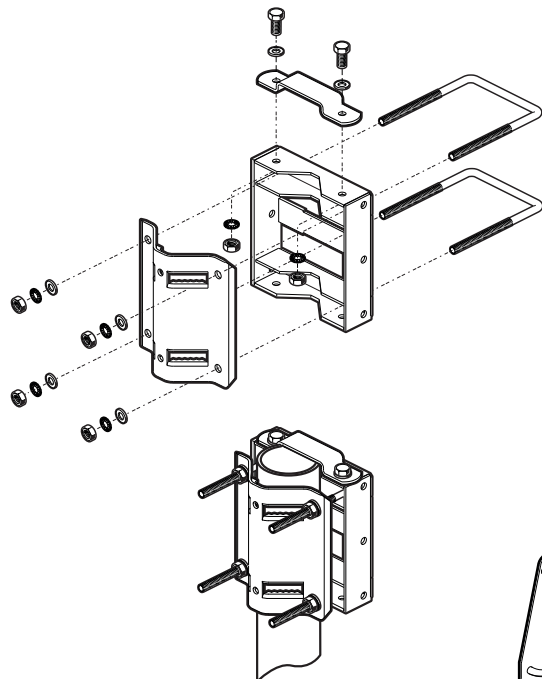

① Assembly of the pole clamp unit



A fixing pole with a diameter from 75mm up to 90mm and thickness of 3mm is highly recommended.

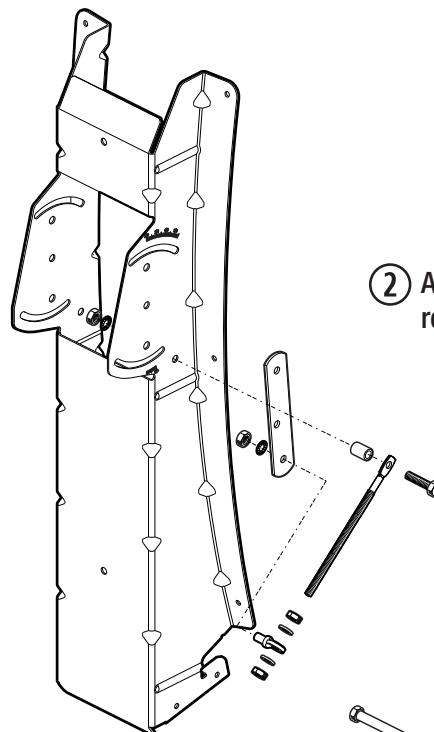

② Assembly of the Elevation fine regulation threaded tie-rod

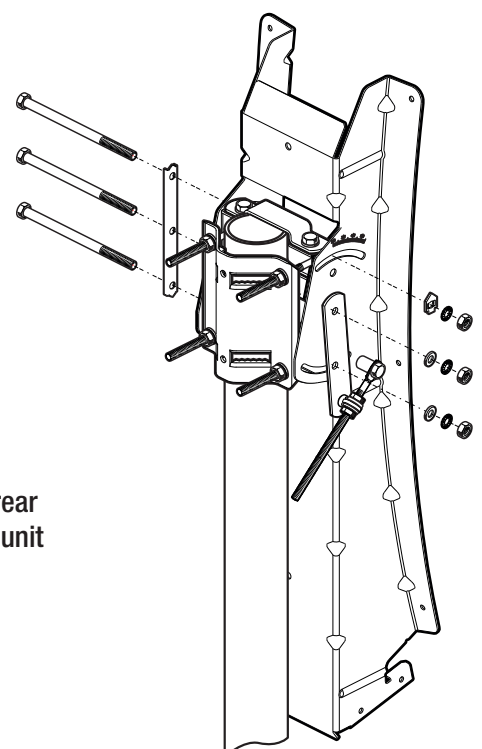

③ Assembly of the antenna rear bracket to the pole clamp unit



ASSEMBLING STEPS

